



Artikel-Nr.	Lagerbestand in Meter	Preis pro Meter / Stück	Qualität
-------------	--------------------------	----------------------------	----------

Zeichnung

A3331

6230 mtr.

0,7086

EPDM

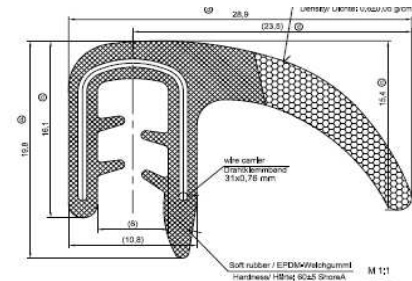

B2 133

256 mtr.

0,8681

EPDM

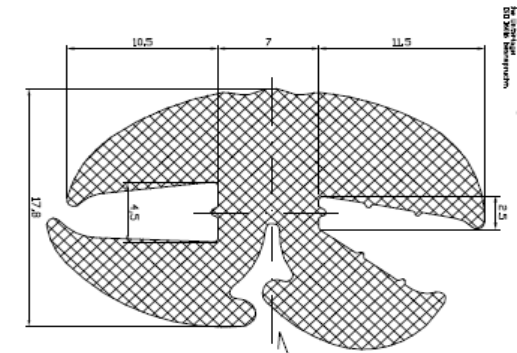

A3171

800 mtr.

0,8387

PVC/EPDM

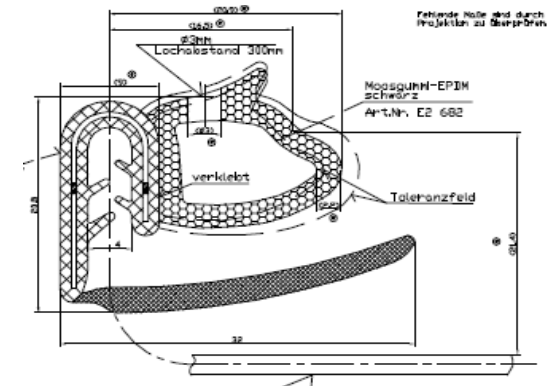



Artikel-Nr.	Lagerbestand in Meter	Preis pro Meter / Stück	Qualität
-------------	--------------------------	----------------------------	----------

Zeichnung

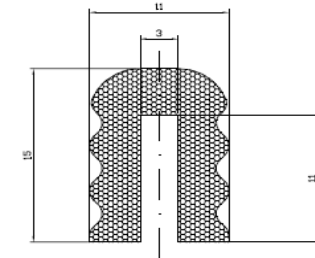

E2 705D	1967 mtr.	0,3542	EPDM
---------	-----------	--------	------

A3527	180 mtr.	0,6981	EPDM
-------	----------	--------	------

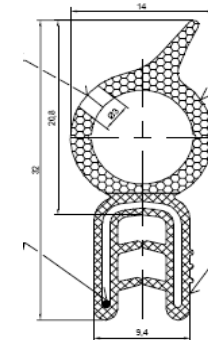

090X61S3	3825 mtr.	0,7978	EPDM
----------	-----------	--------	------

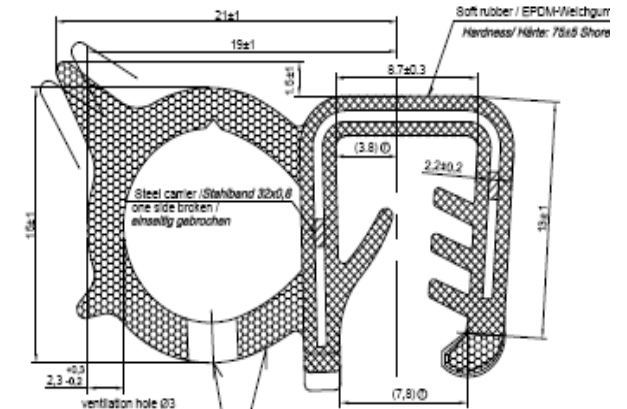

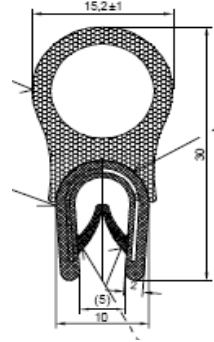
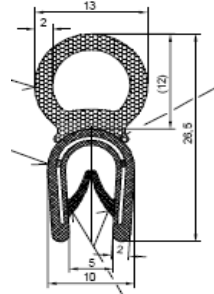
Artikel-Nr.	Lagerbestand in Meter	Preis pro Meter / Stück	Qualität	Zeichnung
A3627	65 mtr.	0,7114	PVC/EPDM	
A3629	65 mtr.	0,6263	PVC/EPDM	



Artikel-Nr.	Lagerbestand in Meter	Preis pro Meter / Stück	Qualität
-------------	--------------------------	----------------------------	----------

Zeichnung

A3633

375 mtr.

1,0808

EPDM

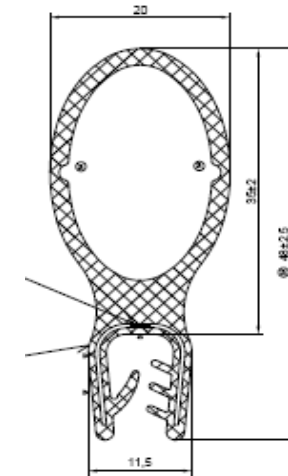

A3713

100 mtr.

0,6720

EPDM

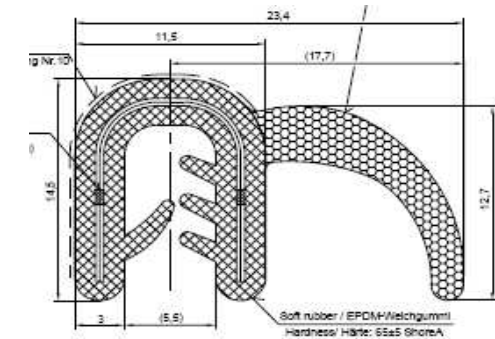



Artikel-Nr. **Lagerbestand
in Meter** **Preis pro
Meter / Stück** **Qualität**

Zeichnung

A2 307MW

990 mtr.

0,7693

PVC/EPDM

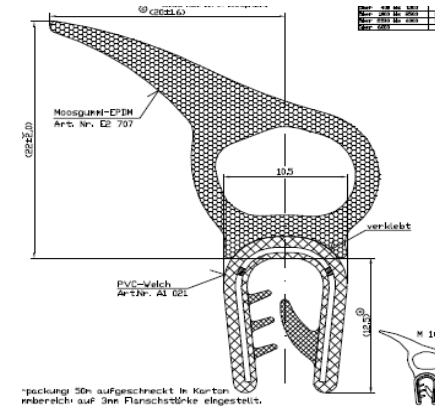

A3323TR

239 mtr.

0,3385

EPDM

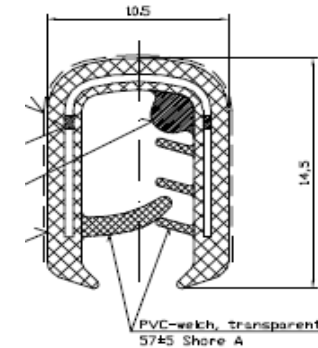

A3440

1500 mtr.

0,2483

PVC

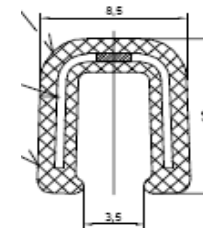



Artikel-Nr.	Lagerbestand in Meter	Preis pro Meter / Stück	Qualität
-------------	--------------------------	----------------------------	----------

Zeichnung

A3540-BU

7300 mtr.

0,5081

EPDM

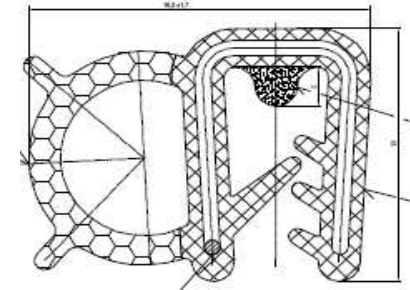

E2 809

1500 mtr.

0,4736

EPDM

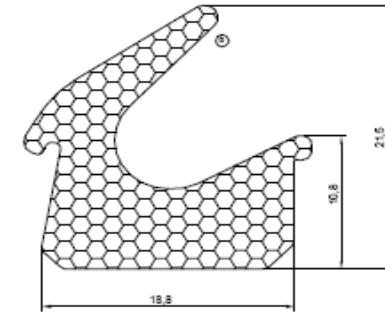

D2 235

150 mtr.

1,3350

EPDM

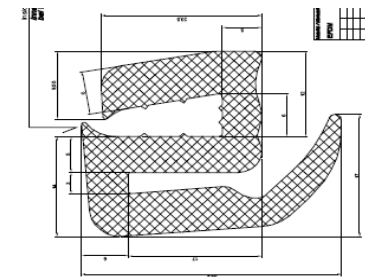



Artikel-Nr. **Lagerbestand
in Meter** **Preis pro
Meter / Stück** **Qualität**

Zeichnung

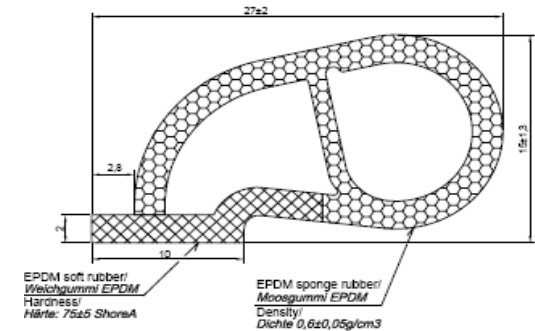

D2 578

1000 mtr.

0,3735

EPDM

A3145

2500 mtr.

0,7308

EPDM

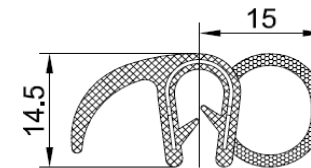

XA1 010-000

2560 mtr.

0,0340

PVC-Weich

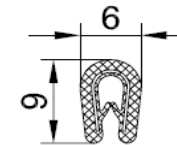

A3574

2325 mtr.

0,6604

EPDM

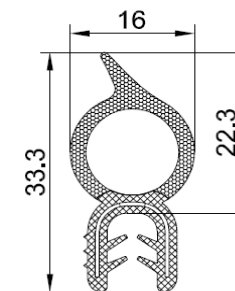



Artikel-Nr.	Lagerbestand in Meter	Preis pro Meter / Stück	Qualität
-------------	--------------------------	----------------------------	----------

Zeichnung

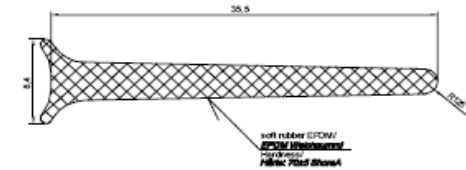

D2 546

3200 mtr.

0,4933

EPDM

A3517

1000 mtr.

0,7623

EPDM

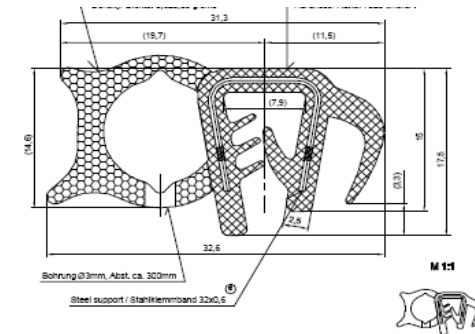

D0011

5195 mtr.

0,2748

EPDM

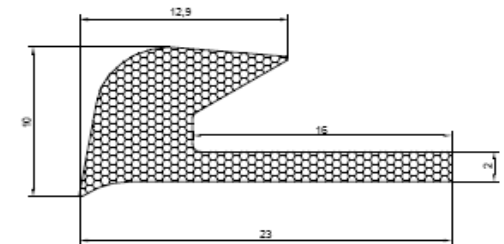

YA 175

42 Stück

1,8733

PVC/EPDM

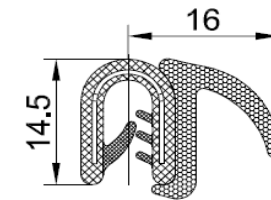



Artikel-Nr.	Lagerbestand in Meter	Preis pro Meter / Stück	Qualität	Zeichnung
-------------	--------------------------	----------------------------	----------	-----------

ZD 108
Rahmen aus
D2 375

50 Stück

2,4479

EPDM

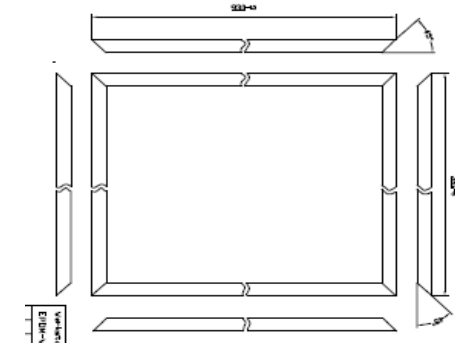

A3306

384 mtr.

0,8141

PVC/EPDM

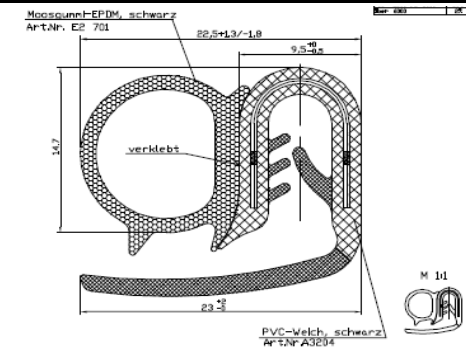

080x61

800 mtr.

PVC/EPDM

siehe Muster

A3276

2000 mtr.

0,7259

EPDM

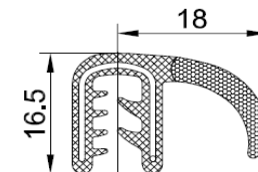



Artikel-Nr. **Lagerbestand
in Meter** **Preis pro
Meter / Stück** **Qualität**

Zeichnung

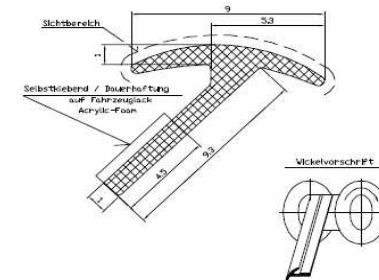

D2 226

900 mtr.

0,6600

EPDM

A3531/6

500 mtr.

0,7983

EPDM

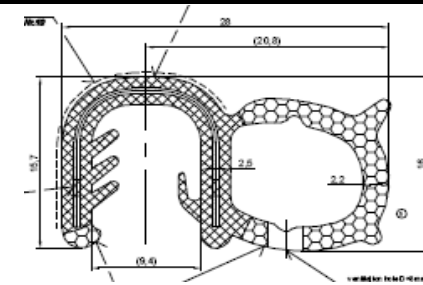

XA 443

90 Stück

0,9077

PVC/EPDM

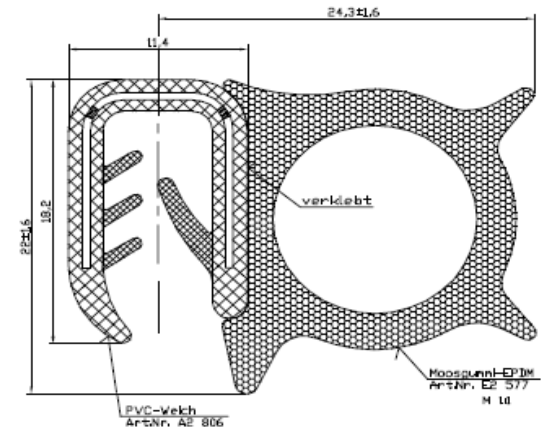



Artikel-Nr. **Lagerbestand
in Meter** **Preis pro
Meter / Stück** **Qualität**

Zeichnung

A3761MA

400 mtr.

1,3292

EPDM

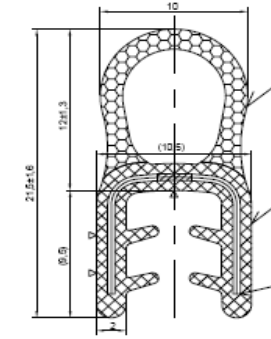

A3756MA

200 mtr.

0,8218

EPDM

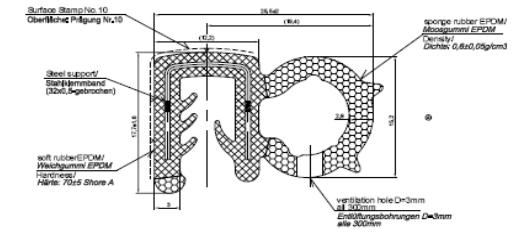

A3276

2000 mtr.

0,7259

EPDM

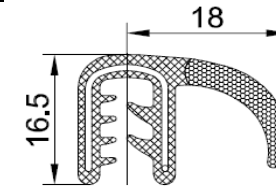

A3747MA

200 mtr.

0,6400

EPDM

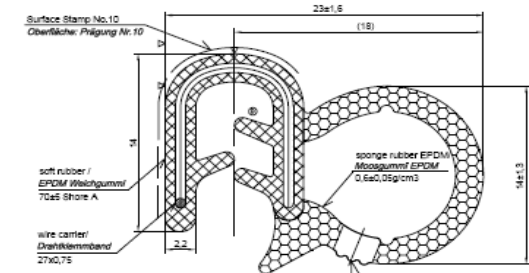



Artikel-Nr.	Lagerbestand in Meter	Preis pro Meter / Stück	Qualität
-------------	--------------------------	----------------------------	----------

Zeichnung

E1 504H-NK

50 mtr.

0,9702

EPDM

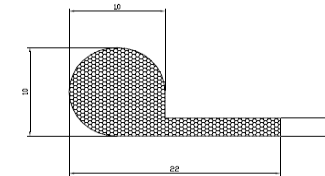

A3666MA

400 mtr.

0,7273

PVC/EPDM

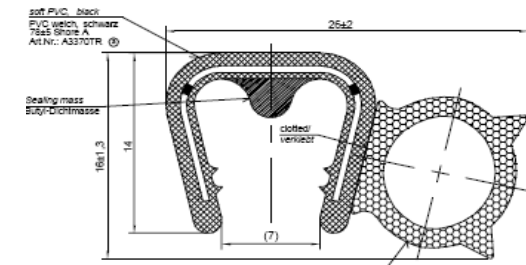

D2 573

1000 mtr.

0,1721

EPDM

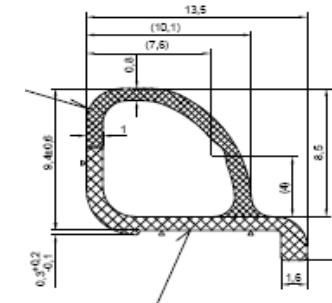

A3512

600 mtr.

0,7264

PVC

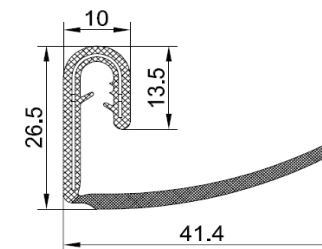



Artikel-Nr.	Lagerbestand in Meter	Preis pro Meter / Stück	Qualität	Zeichnung
-------------	--------------------------	----------------------------	----------	-----------

A3595

175 mtr.

0,9591

PVC/EPDM

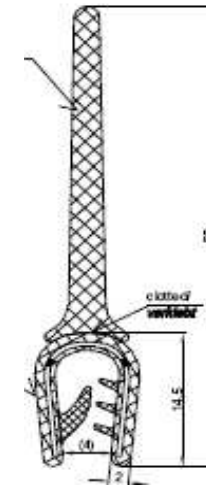

B1 148

255 mtr.

1,2260

EPDM

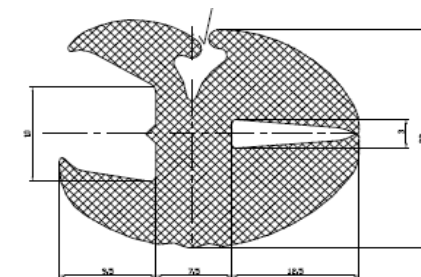

XA3298-0330

8000 Stück

0,0994

PVC

siehe Muster



Artikel-Nr. **Lagerbestand
in Meter** **Preis pro
Meter / Stück** **Qualität**

Zeichnung

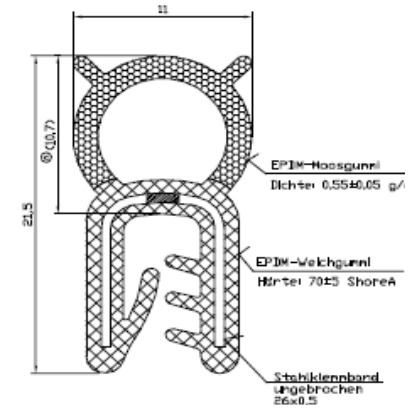

A2 557

3000 mtr.

0,5498

EPDM

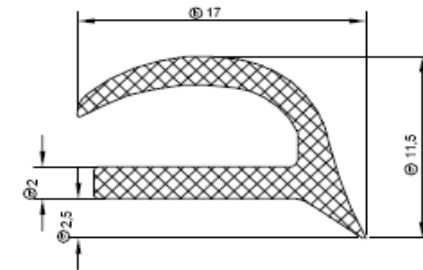

G2 303

4000 mtr.

0,2637

PVC

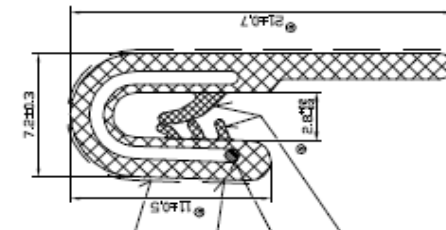

A3045

4000 mtr.

0,2532

PVC



Artikel-Nr.	Lagerbestand in Meter	Preis pro Meter / Stück	Qualität
-------------	--------------------------	----------------------------	----------

Zeichnung

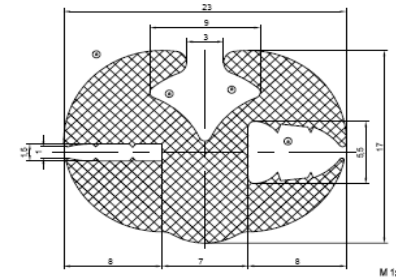

B2 209

175 mtr.

0,7179

EPDM

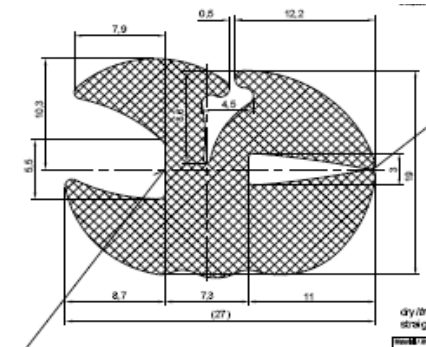

B2 221MA

50 mtr.

1,4775

EPDM

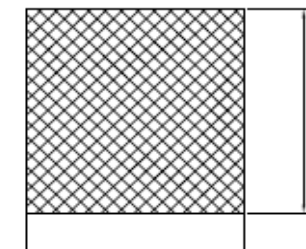

D2 287

200 mtr.

0,6561

EPDM



Artikel-Nr.	Lagerbestand in Meter	Preis pro Meter / Stück	Qualität	Zeichnung
D1 125	900 mtr.	1,4644	EPDM	
E2 848	1210 mtr.	0,4188	EPDM	
A2 087MW	520 mtr.	0,5357	PVC	



Artikel-Nr.	Lagerbestand in Meter	Preis pro Meter / Stück	Qualität
-------------	--------------------------	----------------------------	----------

Zeichnung

XA3488-0454
Fixlänge a
454 mm

5700 Stück

0,2022

PVC-Weich

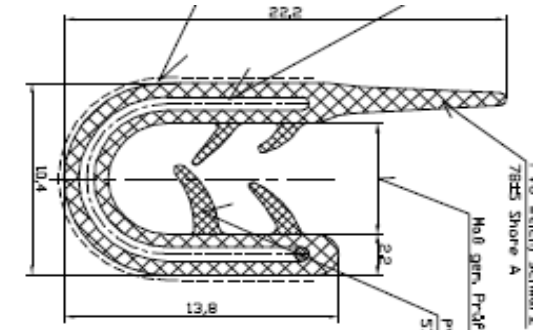

XA 445
Fixlänge a
420 mm

400 Stück

3,0251

PVC/EPDM

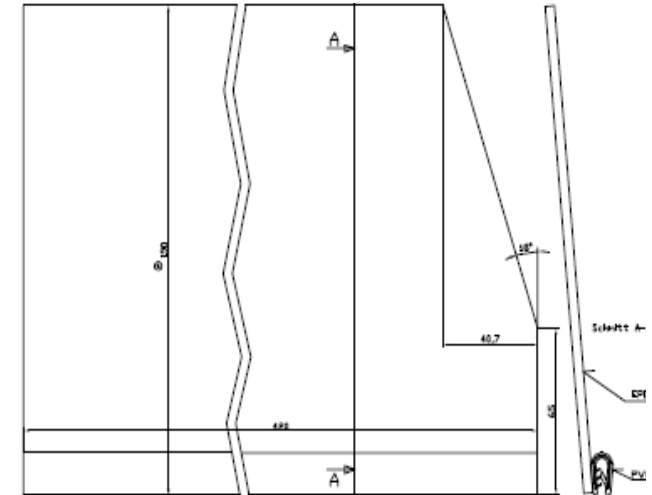



Artikel-Nr.	Lagerbestand in Meter	Preis pro Meter / Stück	Qualität	Zeichnung
-------------	--------------------------	----------------------------	----------	-----------

A3012

600 mtr.

0,6017

PVC

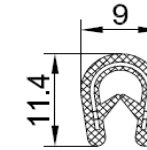

D2 579MA

300 mtr.

0,3250

EPDM

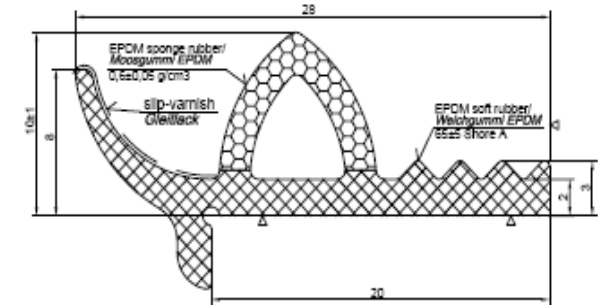

A3493-BU

1110 mtr.

0,9373

PVC

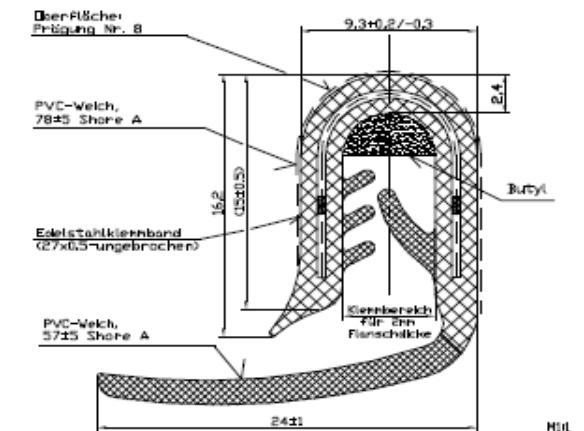



Artikel-Nr. **Lagerbestand
in Meter** **Preis pro
Meter / Stück** **Qualität**

Zeichnung

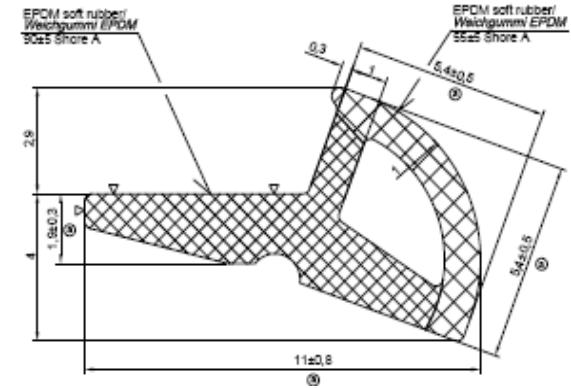

D2 583

30 mtr.

0,1748

EPDM

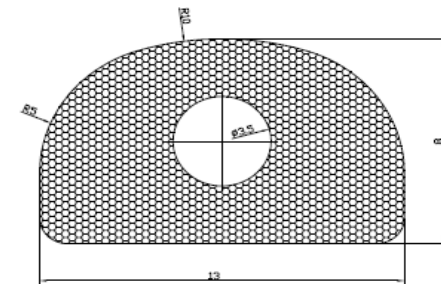

E2 748

1580 mtr.

0,3175

EPDM



Artikel-Nr. **Lagerbestand
in Meter** **Preis pro
Meter / Stück** **Qualität**

Zeichnung

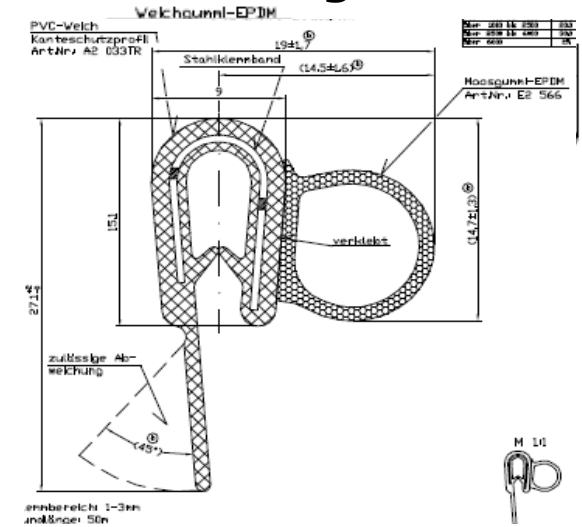

A2 244

400 mtr.

0,6405

PVC/EPDM

E2 830

50 mtr.

0,2915

EPDM

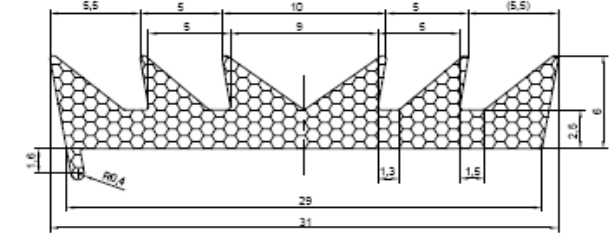



Artikel-Nr. **Lagerbestand**
in Meter

Preis pro
Meter / Stück

Qualität

Zeichnung

A3553

675 mtr.

0,6571

EPDM

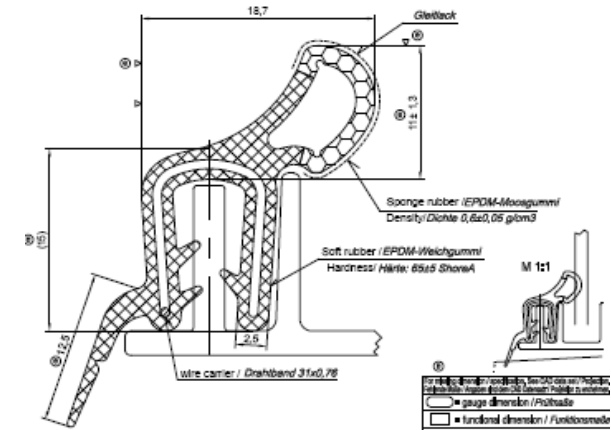

A3405

800 mtr.

0,7362

PVC/EPDM

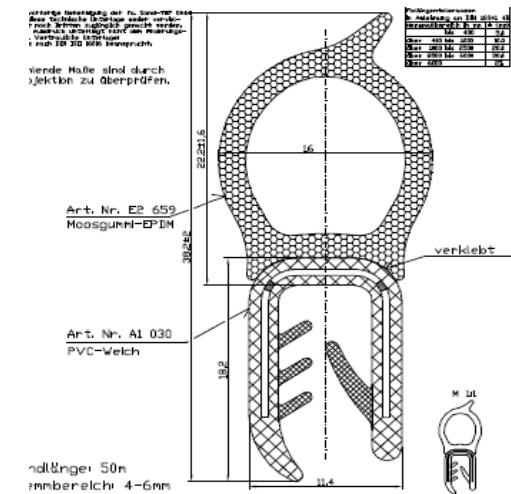



Artikel-Nr.	Lagerbestand in Meter	Preis pro Meter / Stück	Qualität
-------------	--------------------------	----------------------------	----------

Zeichnung

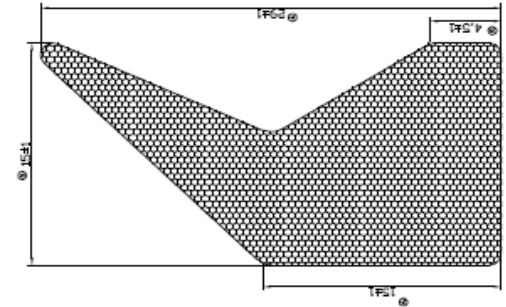

E2 775

525 mtr.

0,3542

EPDM

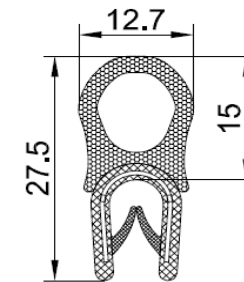

XA 420

300 Stück

1,2958

PVC/EPDM

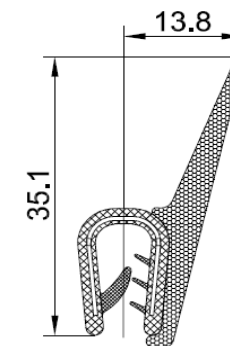

XA3073-0870

Fixlänge a
870 mm

100 Stk.

0,8378

PVC/EPDM